

USD REDIRECT MUFFLERS

**COMFORT
VENTILATION**

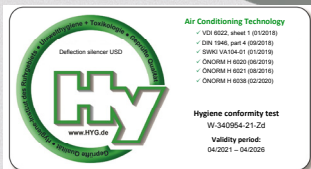
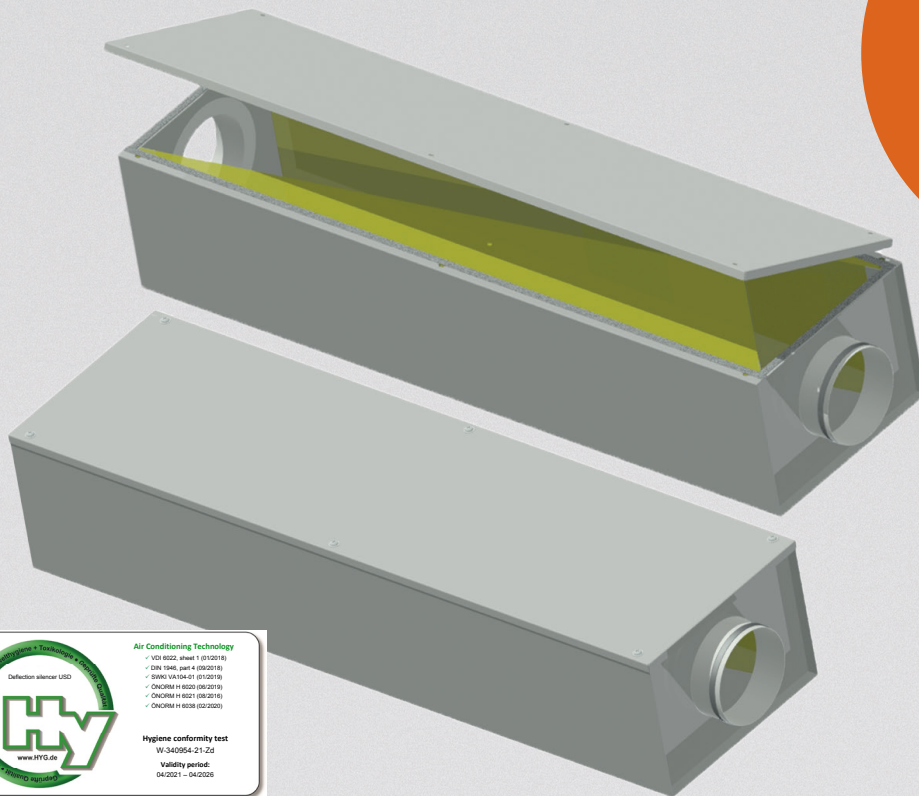

with or without inspection cover

 **PICHLER**

Systematic ventilation.

Product description USD(R)

- Square sound absorbers with acoustically and flow optimised splitters
- Galvanised steel sheet outer housing
- Splitters with high-strength, wear-resistant and moisture repellent glass silk surface with absorption and resonance elements for optimal sound damping
- Connecting stubs with double lip sealing for plug-in fitting

- Version USD-R with screwed inspection cover for easy cleaning purposes
- Version USD-EZ without inspection with eccentric connection for easy cleaning purposes

HYGIENE-CERTIFIED BY THE RUHR DISTRICT INSTITUTE OF HYGIENE

The construction design complies with hygiene requirements as stipulated in the guidelines contained in VDI 6022 (sheet 1, 01/2018), SWKI VA104-01

(01/2019), DIN 1946 (part 4, 09/2018), ÖNORM H 6021 (08/2016), ÖNORM H 6020 (06/2019) and ÖNORM H 6038 (02/2020), and is in accordance with performed expert appraisals on hygiene.

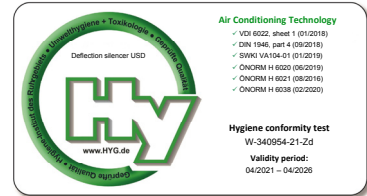

Dimensions and assembly

Article number	Description	ØD [mm]	W [mm]	H [mm]	L [mm]	V [mm]	Damping at 250 Hz [db]	Weight [kg]	Volume flow* [m³/h]	Pressure loss* [Pa]
08USD100	redirect muffler without inspection	100	280	200	1000		29	10,2	85	12
08USD125	redirect muffler without inspection	125	280	200	1000		29	10,5	133	17
08USD160	redirect muffler without inspection	160	260	280	1000		28	12,5	217	19
08USD180	redirect muffler without inspection	180	350	232	1000		20	15	275	28
08USD180EZ	redirect muffler without inspection, eccentric connections	180	350	232	1000	55	20	15	275	28
08USD200	redirect muffler without inspection	200	260	280	1000		27	12,5	339	42
08USD200G	redirect muffler without inspection	200	240	380	1000		20	17,0	339	24
08USD250	redirect muffler without inspection	250	450	500	1000		21	26,0	530	15
08USD315	redirect muffler without inspection	315	450	500	1000		15	26,6	842	16
08USD1000700	redirect muffler without inspection	100	280	200	700		18	7,5	85	9
08USD1250700	redirect muffler without inspection	125	280	200	700		17	7,5	133	13
08USD1600700	redirect muffler without inspection	160	260	280	700		14	9,0	217	15
08USD1800700	redirect muffler without inspection	180	350	232	700		16	11,5	275	20
08USD2000700	redirect muffler without inspection	200	260	280	700		16	9,0	339	30
08USD2500700	redirect muffler without inspection	250	450	500	700		14	18,0	530	9
08USD3150700	redirect muffler without inspection	315	450	500	700		14	18,0	842	16
08USDR100	redirect muffler with inspection	100	280	200	1000		29	10,2	85	12
08USDR125	redirect muffler with inspection	125	280	200	1000		29	10,5	133	17
08USDR160	redirect muffler with inspection	160	260	280	1000		28	12,5	217	19
08USDR200	redirect muffler with inspection	200	260	280	1000		27	12,5	339	42
08USDR250	redirect muffler with inspection	250	450	500	1000		21	26,0	530	15
08USDR315	redirect muffler with inspection	315	450	500	1000		15	26,6	842	16

* at an air speed of 3 m/sec

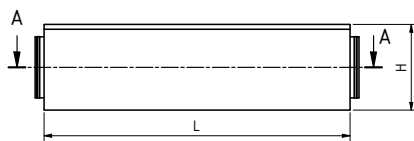

Front view USD(R)

A-A

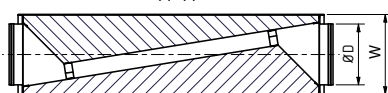

Top view (cross-sectional view) USD(R)

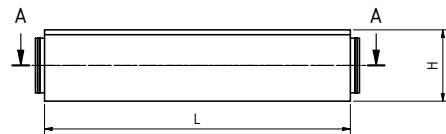

Front view USD-EZ

A-A

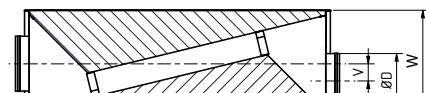

Top view (cross-sectional view) USD-EZ



Technical data

DEFLECTION SILENCER USD WITH L = 1000 MM

INSERTION LOSS

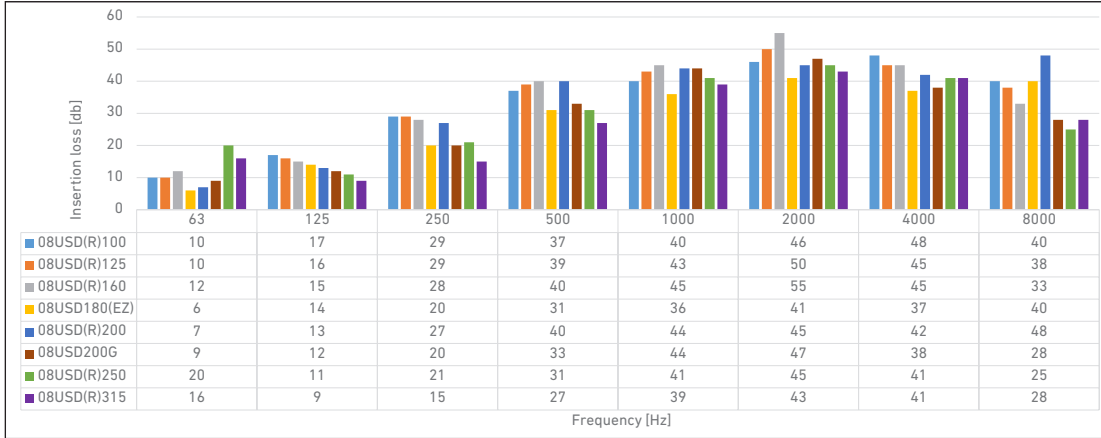

PRESSURE LOSS DIAGRAM

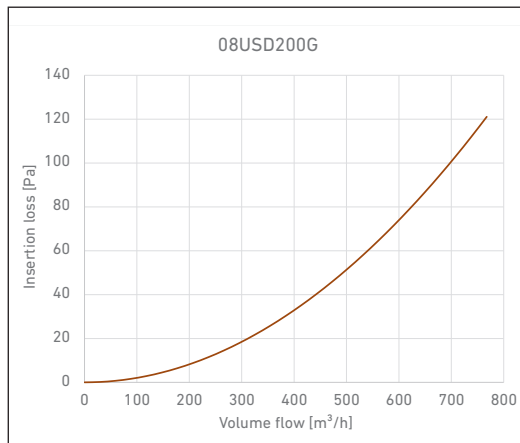
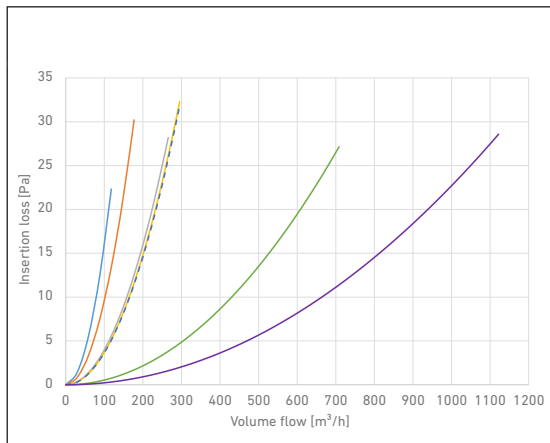

DEFLECTION SILENCER USD WITH L = 1000 MM

INSERTION LOSS

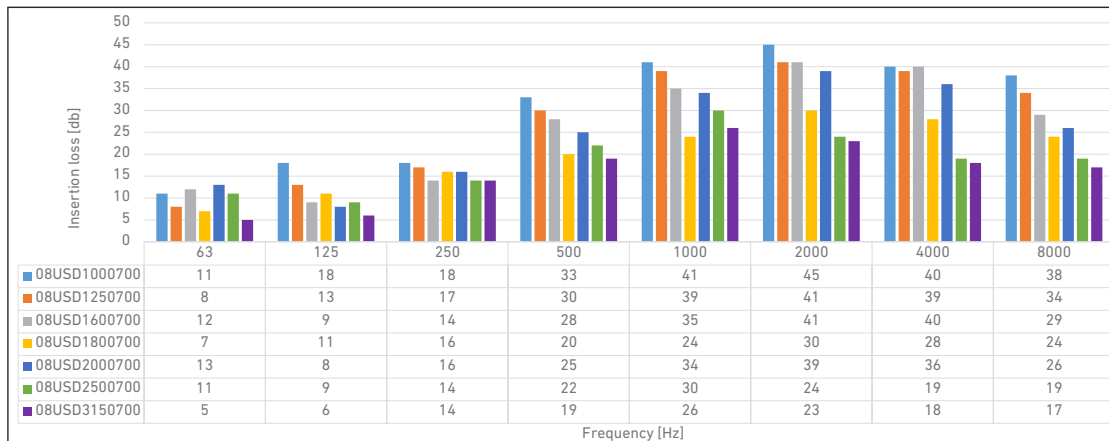

PRESSURE LOSS DIAGRAM

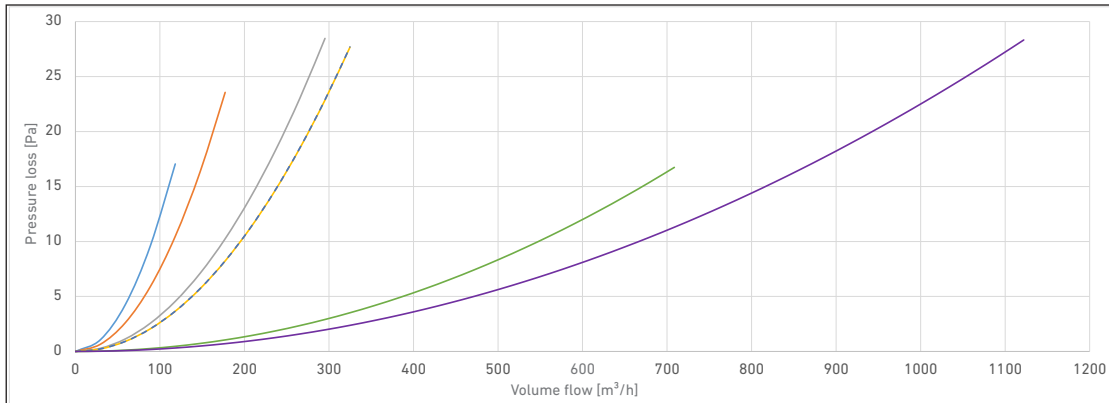

Product description USDD

- Square sound absorbers with 2 integrated and consecutive splitters with absorption and resonance elements for optimal sound damping
- Galvanised steel sheet outer housing
- Splitters with high-strength, wear-resistant and moisture repellent glass silk surface
- Connecting stubs with double lip sealing for plug-in fitting
- Without Hygiene-certificate

Dimensions and assembly

Article number	Beschreibung	ØD [mm]	W [mm]	H [mm]	L [mm]	Damping at 250 Hz [db]	Weight [kg]	Volume flow* [m³/h]	Pressure loss* [Pa]
08USDD1001200	dual, flat redirect muffler without inspection	100	202	134	1200	30	8,5	85	20
08USDD1251200	dual, flat redirect muffler without inspection	125	202	134	1200	30	7,0	133	31

* at an air speed of 3 m/sec

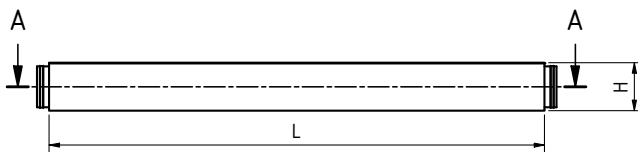

Front view USDD

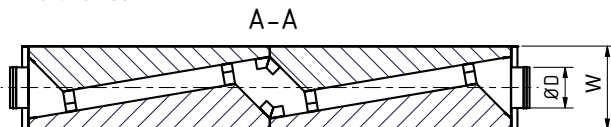

Top view (cross-sectional view) USDD



Technical data

DEFLECTION SILENCER USDD WITH L = 1200 MM

INSERTION LOSS

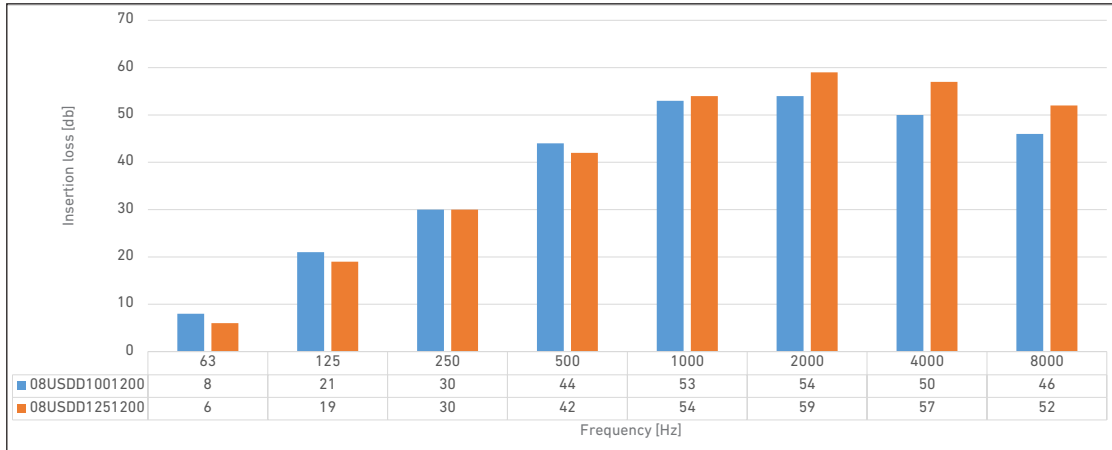

PRESSURE LOSS DIAGRAM

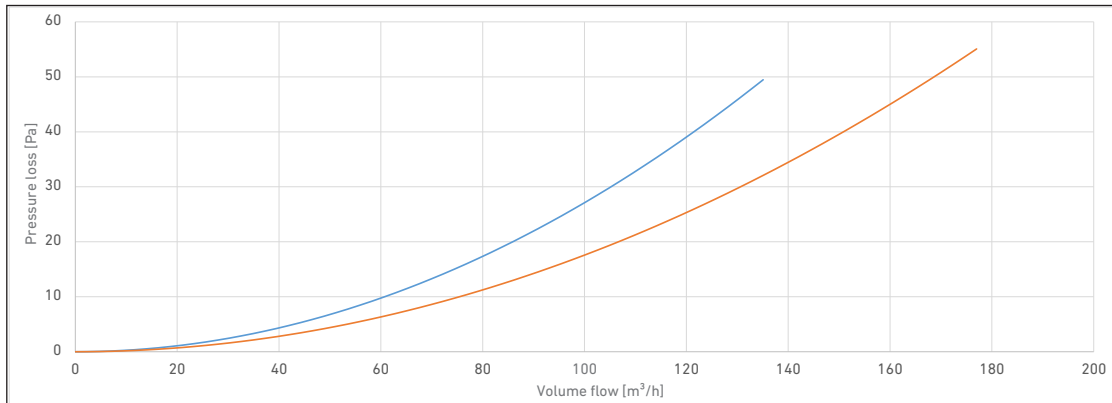

Product description USDF

- Square sound absorbers with acoustically and flow optimised splitters in flat design
- Galvanised steel sheet outer housing
- Splitters with high-strength, wear-resistant and moisture repellent glass silk surface with absorption and resonance elements for optimal sound damping
- Connecting stubs with double lip sealing for plug-in fitting
- Without Hygiene-certificate

Dimensions and assembly

Article number	Beschreibung	ØD [mm]	W [mm]	H [mm]	L [mm]	Damping at 250 Hz [db]	Weight [kg]	Volume flow* [m ³ /h]	Pressure loss* [Pa]
08USDF100600	flat redirect muffler without inspection	100	202	115	600	15	4,0	85	17

* at an air speed of 3 m/sec

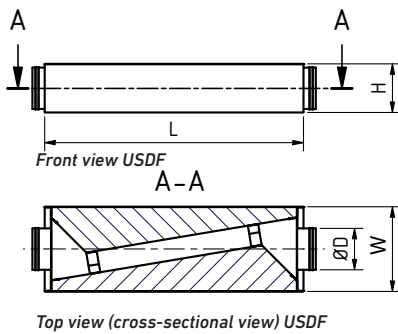

Technical data

DEFLECTION SILENCER USDF MIT L = 600 MM

INSERTION LOSS

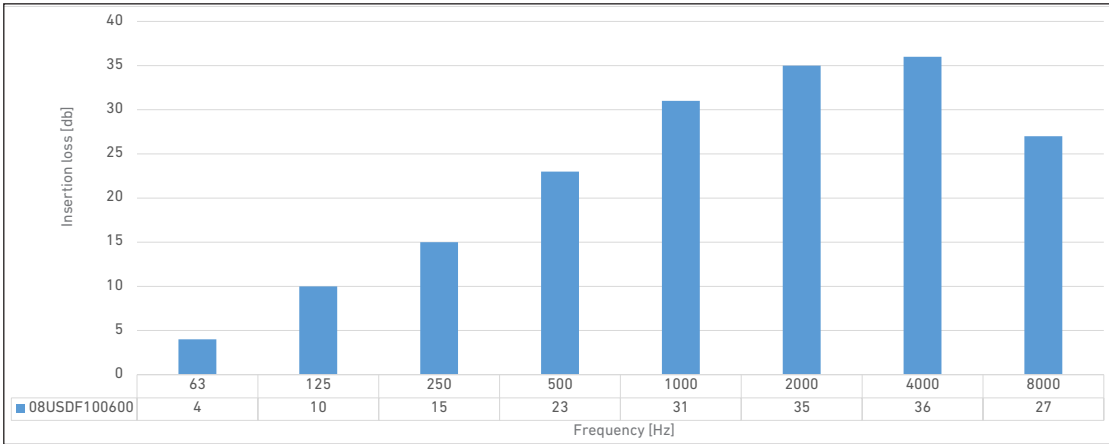

PRESSURE LOSS DIAGRAM

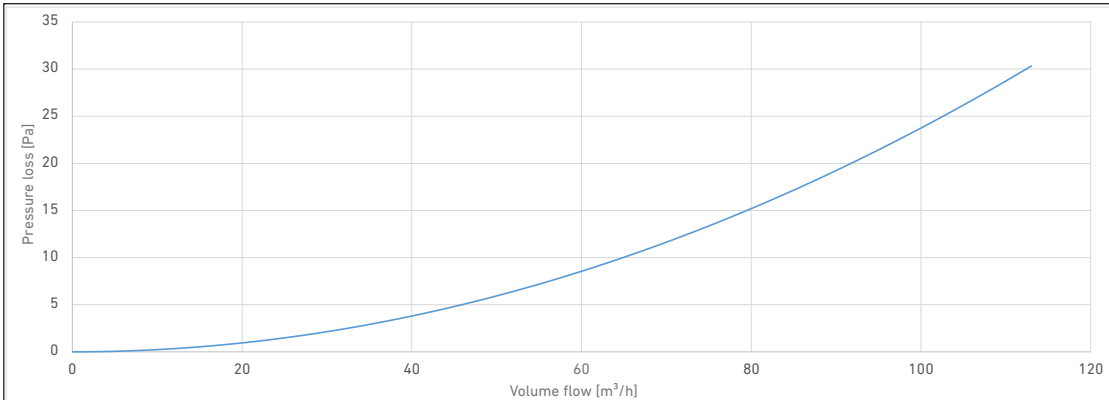



Responsible for the content: J. Pichler Gesellschaft m.b.H. | Graphics and layout: WERK1
 Photos: Archiv J. Pichler Gesellschaft m.b.H. | Text: J. Pichler Gesellschaft m.b.H.
 All rights reserved | All photos are symbolic photos | Subject to change without notice | Version: 08/2023 eh

PICHLER
 Systematic ventilation.

J. PICHLER
 Gesellschaft m.b.H.

AUSTRIA
9021 KLAGENFURT
AM WÖRTHERSEE
 Karlweg 5
 T +43 (0)463 32769
 F +43 (0)463 37548

1100 VIENNA
 Doerenkampgasse 5
 T +43 (0)1 6880988
 F +43 (0)1 6880988-13

office@pichlerluft.at
 www.pichlerluft.at

PICHLER & CO d.o.o.
 prezračevalni sistemi

SLOVENIA
2000 MARIBOR
 Cesta k Tamu 26
 T +386 (0)2 46013-50
 F +386 (0)2 46013-55

pichler@pichler.si
 www.pichler.si

KLIMA DOP d.o.o.
 klimatizacija i ventilacija

SERBIA
11070 NOVI BEOGRAD
 Autoput Beograd-Zagreb
 bb (Blok 52 – prostor GP
 „Novi Kolektiv“)
 T +381 (0)11 3190177
 F +381 (0)11 3190563

office@klimadop.com
 www.klimadop.com

Sales offices in Slovenia
 and Serbia.
 Sales partners in Europe.